





Vehicle History Report™

2017 JAGUAR XE R-SPORT

VIN: SAJAF4BVXHA970920
 SEDAN 4 DR
 3.0L V6 F DOHC 24V
 GASOLINE
 REAR WHEEL DRIVE

 Accident reported

 15 Service history records

 2 Previous owners

 Personal vehicle

 Last owned in Florida

 57,671 Last reported odometer reading

This CARFAX Vehicle History Report is based only on information supplied to CARFAX and available as of 12/14/22 at 12:46:54 PM (CST). Other information about this vehicle, including problems, may not have been reported to CARFAX. Use this report as one important tool, along with a vehicle inspection and test drive, to make a better decision about your next used car.



Ownership History





The number of owners is estimated

	Owner 1	Owner 2
Year purchased	2017	2019
Type of owner	Personal	Personal
Estimated length of ownership	1 yr. 5 mo.	3 yrs. 3 mo.
Owned in the following states/provinces	Florida	Florida
Estimated miles driven per year	14,761/yr	12,765/yr
Last reported odometer reading	15,166	57,671



Title History

CARFAX guarantees the information in this section





	Owner 1	Owner 2
Damage Brands Salvage Junk Rebuilt Fire Flood Hail Lemon	 Guaranteed No Problem	 Guaranteed No Problem
Odometer Brands Not Actual Mileage Exceeds Mechanical Limits	 Guaranteed No Problem	 Guaranteed No Problem







GUARANTEED - None of these major title problems were reported by a state Department of Motor Vehicles (DMV). If you find that any of these title problems were reported by a DMV and not



 Additional History Not all accidents / issues are reported to CARFAX	Owner 1	Owner 2
Total Loss No total loss reported to CARFAX.	<input checked="" type="checkbox"/> No Issues Reported	<input checked="" type="checkbox"/> No Issues Reported
Structural Damage CARFAX recommends that you have this vehicle inspected by a collision repair specialist.	<input checked="" type="checkbox"/> No Issues Reported	<input checked="" type="checkbox"/> No Issues Reported
Airbag Deployment No airbag deployment reported to CARFAX.	<input checked="" type="checkbox"/> No Issues Reported	<input checked="" type="checkbox"/> No Issues Reported
Odometer Check No indication of an odometer rollback.	<input checked="" type="checkbox"/> No Issues Indicated	<input checked="" type="checkbox"/> No Issues Indicated
Accident / Damage Accident reported: 07/30/2017. Damage reported: 04/11/2018.	Accident Reported	No New Issues Reported
Manufacturer Recall No open recalls reported to CARFAX. Check with an authorized Jaguar dealer for any open recalls.	<input checked="" type="checkbox"/> No Recalls Reported	<input checked="" type="checkbox"/> No Recalls Reported
Basic Warranty Original warranty estimated to have expired.	Warranty Expired	Warranty Expired

 **Detailed History**

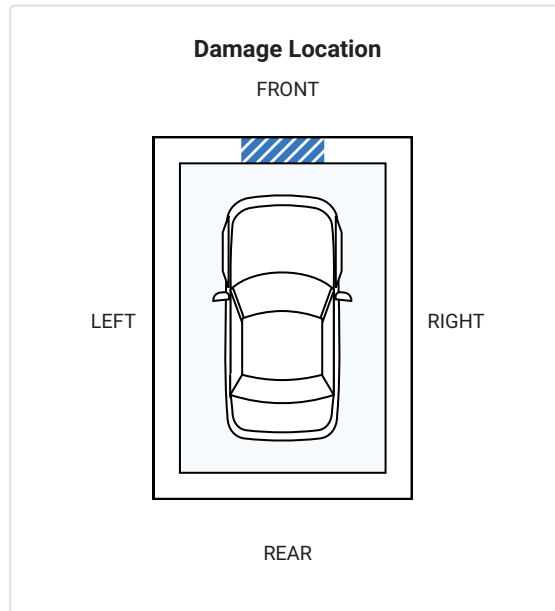

 Owner 1 Purchased: 2017		Low mileage! This owner drove less than the industry average of 15,000 miles per year.	Personal Vehicle 14,761 mi/yr
Date	Mileage	Source	Comments
12/13/2016	13	Jaguar Land Rover South Orlando Orlando, FL 407-452-3891  4.6 / 5.0 183 Verified Reviews  3,207 Customer Favorites	 Vehicle serviced - Pre-delivery inspection completed - Nitrogen fill tires
12/16/2016		Dealer Inventory	Vehicle offered for sale

01/20/2017	Jaguar Land Rover South Orlando Orlando, FL 407-452-3891 ★ 4.6 / 5.0 183 Verified Reviews ❤️ 3,20 Customer 7 Favorites	 Vehicle serviced
01/30/2017 14	Jaguar Land Rover South Orlando Orlando, FL 407-452-3891 ★ 4.6 / 5.0 183 Verified Reviews ❤️ 3,20 Customer 7 Favorites	 Vehicle serviced
04/13/2017 37	Florida Motor Vehicle Dept. Orlando, FL Title #0126887651	Vehicle purchase reported - Title issued or updated - Registration issued or renewed - First owner reported - Titled or registered as personal vehicle - Loan or lien reported - Vehicle color noted as Maroon
05/11/2017	Florida Motor Vehicle Dept. Orlando, FL Title #0127167348	Title issued or updated - Registration issued or renewed - Titled or registered as personal vehicle - Loan or lien reported - Vehicle color noted as Maroon
06/20/2017 4,015	Jaguar Land Rover South Orlando Orlando, FL 407-452-3891 ★ 4.6 / 5.0 183 Verified Reviews ❤️ 3,20 Customer 7 Favorites	 Vehicle serviced - Maintenance inspection completed - Tire pressure sensor checked - Body electrical system checked
07/30/2017	Damage Report	 Accident reported - It hit a stationary object - It hit a curb - Damage to front - Disabling damage reported - Vehicle towed - Airbags did not deploy



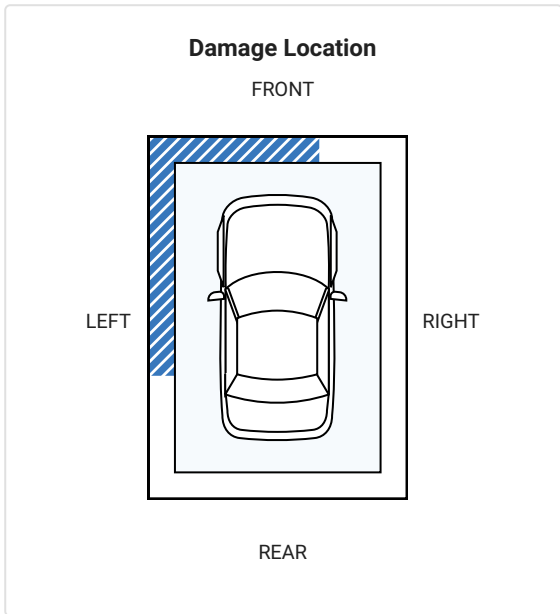
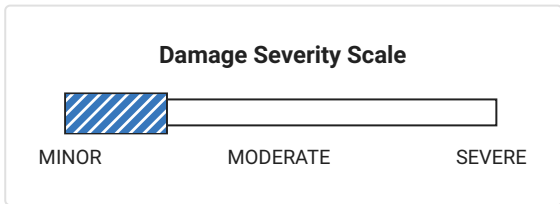

08/11/2017	Florida Service Facility	Mechanical issue reported - Vehicle towed
12/01/2017 5,780	Jaguar Land Rover South Orlando Orlando, FL 407-452-3891 ★ 4.6 / 5.0 183 Verified Reviews ❤️ 3,20 Customer 7 Favorites	 Vehicle serviced - Four wheel alignment performed - Body electrical system checked
12/18/2017	Florida Motor Vehicle Dept. Orlando, FL Title #0127167348	Registration issued or renewed - Titled or registered as personal vehicle - Loan or lien reported - Vehicle color noted as Maroon
12/21/2017 6,110	Jaguar Land Rover South Orlando Orlando, FL 407-452-3891 ★ 4.6 / 5.0 183 Verified Reviews ❤️ 3,20 Customer 7 Favorites	 Vehicle serviced - Heater hose(s) replaced - Cooling system checked
04/11/2018	Damage Report	 Damage reported: minor damage - Damage to front - Damage to left front - Damage to left side







04/23/2018	15,166	Jaguar Land Rover South Orlando Orlando, FL 407-452-3891 ★ 4.6 / 5.0 183 Verified Reviews ❤️ 3,207 Customer Favorites	 Vehicle serviced - Maintenance inspection completed - Rear brakes replaced - Front brakes replaced - Drivability/performance checked
08/23/2018	Florida Motor Vehicle Dept. Fort Worth, TX Title #0127167348	Title issued or updated - Vehicle repossessed - Vehicle color noted as Maroon	
09/24/2018	Auto Auction	Vehicle sold	
		Millions of used vehicles are bought and sold at auction every year.	
09/27/2018	Dealer Inventory	Vehicle offered for sale	
10/02/2018	HGreg.com Miami Miami, FL 305-909-7859 ★ 3.5 / 5.0 29 Verified Reviews	 Vehicle serviced - Wiper(s) replaced	

10/24/2018	HGreg.com Miami Miami, FL 305-909-7859 ★ 3.5 / 5.0 29 Verified Reviews	 Vehicle serviced - Four tires balanced - Four tires mounted - Tire condition and pressure checked - Two tires mounted - Two tires balanced - Tire(s) balanced - Tire(s) mounted
12/17/2018	HGreg.com Miami Miami, FL 305-909-7859 ★ 3.5 / 5.0 29 Verified Reviews	 Vehicle serviced - Steering/suspension checked

 Owner 2 Purchased: 2019		Low mileage! This owner drove less than the industry average of 15,000 miles per year.	Personal Vehicle 12,765 mi/yr
---	---	---	----------------------------------

Date	Mileage	Source	Comments
07/20/2019	15,246	Florida Motor Vehicle Dept.	Vehicle purchase reported
08/03/2019		Florida Motor Vehicle Dept. Tampa, FL Title #0127167348	Title issued or updated - Registration issued or renewed - New owner reported - Titled or registered as personal vehicle - Loan or lien reported - Vehicle color noted as Maroon
01/30/2020		Tire Kingdom Tampa, FL 813-628-0800 ★ 4.5 / 5.0 54 Verified Reviews ♥ 71 Customer Favorites	 Vehicle serviced - Tire condition and pressure checked - Tire(s) replaced - Tire repaired - Tire(s) balanced - Tires rotated - Tire pressure monitoring system serviced - Tire(s) mounted - Battery/charging system checked
07/21/2020		Florida Motor Vehicle Dept. Tampa, FL Title #0127167348	Registration issued or renewed - Titled or registered as personal vehicle - Loan or lien reported - Vehicle color noted as Maroon

08/28/2020		<p>Tire Kingdom Tampa, FL 813-628-0800</p> <p>★ 4.5 / 5.0 54 Verified Reviews ♥ 71 Customer Favorites</p>	 <p>Vehicle serviced</p> <ul style="list-style-type: none"> - Tire condition and pressure checked - Alignment performed - Tire(s) replaced - Tire repaired - Tire(s) balanced - Tires rotated - Tire pressure monitoring system serviced - Tire(s) mounted - Battery/charging system checked - Alignment checked
12/04/2020		<p>Tire Kingdom Tampa, FL 813-628-0800</p> <p>★ 4.5 / 5.0 54 Verified Reviews ♥ 71 Customer Favorites</p>	 <p>Vehicle serviced</p> <ul style="list-style-type: none"> - Alignment performed - Tire condition and pressure checked - Tire(s) replaced - Tire repaired - Tire(s) balanced - Tires rotated - Tire pressure monitoring system serviced - Tire(s) mounted - Battery/charging system checked
02/05/2021		<p>Florida Motor Vehicle Dept. Riverview, FL Title #0127167348</p>	<p>Registration issued or renewed</p> <ul style="list-style-type: none"> - Titled or registered as personal vehicle - Registration updated when owner moved the vehicle to a new location - Vehicle color noted as Maroon
02/22/2021		<p>Tire Kingdom Tampa, FL 813-628-0800</p> <p>★ 4.5 / 5.0 54 Verified Reviews ♥ 71 Customer Favorites</p>	 <p>Vehicle serviced</p> <ul style="list-style-type: none"> - Tire condition and pressure checked - Battery/charging system checked - Tire(s) balanced - Tire pressure monitoring system serviced - Tire repaired
01/03/2022		<p>Florida Motor Vehicle Dept. Riverview, FL Title #0127167348</p>	<p>Registration issued or renewed</p> <ul style="list-style-type: none"> - Titled or registered as personal vehicle - Vehicle color noted as Maroon
10/08/2022	57,667	<p>Florida Motor Vehicle Dept. Riverview, FL</p>	<p>Odometer reading reported</p>
10/13/2022	57,668	<p>Courtesy Hyundai Tampa, FL 833-677-9472</p> <p>★ 4.2 / 5.0 536 Verified Reviews ♥ 302 Customer Favorites</p>	 <p>Vehicle serviced</p> <ul style="list-style-type: none"> - Vehicle washed/detailed

11/14/2022	57,671	Auto Auction	Listed as a dealer vehicle - Vehicle sold
11/21/2022		Florida Motor Vehicle Dept. Riverview, FL Title #0127167348	Title issued or updated - Duplicate title issued - Vehicle color noted as Maroon

Have Questions? Please visit our Help Center at www.carfax.com.



Glossary

Accident Indicator

CARFAX receives information about accidents in all 50 states, the District of Columbia and Canada.

Not every accident is reported to CARFAX. As details about the accident become available, those additional details are added to the CARFAX Vehicle History Report. CARFAX recommends that you have this vehicle inspected by a qualified mechanic.

- According to the National Safety Council, Injury Facts, 2021 edition, 5% of the 276 million registered vehicles in the U.S. were involved in an accident in 2019. Over 77% of these were considered minor or moderate.
- This CARFAX Vehicle History Report is based only on information supplied to CARFAX and available as of 12/14/22 at 12:46:54 PM (CST). Other information about this vehicle, including problems, may not have been reported to CARFAX. Use this report as one important tool, along with a vehicle inspection and test drive, to make a better decision about your next used car.

Damage Indicator

Damage can be a result of many different types of events. Examples include contact with objects (other cars, trees, traffic signs, road debris, etc), vandalism, or weather-related events. Not every damage event is reported to CARFAX. As details about the damage event become available, those additional details are added to the CARFAX Vehicle History Report. CARFAX recommends that you have this vehicle inspected by a qualified mechanic.

- This CARFAX Vehicle History Report is based only on information supplied to CARFAX and available as of 12/14/22 at 12:46:54 PM (CST). Other information about this vehicle, including problems, may not have been reported to CARFAX. Use this report as one important tool, along with a vehicle inspection and test drive, to make a better decision about your next used car.

Damage Severity

Damage events result in one of the following severity levels:

- Minor: Generally, minor damage is cosmetic (including dents or scratches), may only require reconditioning, and typically does not compromise a vehicle's operation and/or safety.
- Moderate: Moderate damage may affect multiple components of the vehicle and may impair the vehicle's operation and/or safety.
- Severe: Severe damage usually affects multiple components of the vehicle and is likely to compromise the vehicle's operation and/or safety.

CARFAX recommends getting a pre-purchase inspection at a certified collision repair facility.

First Owner

When the first owner(s) obtains a title from a Department of Motor Vehicles as proof of ownership.

New Owner Reported

When a vehicle is sold to a new owner, the Title must be transferred to the new owner(s) at a Department of Motor Vehicles.

Ownership History

CARFAX defines an owner as an individual or business that possesses and uses a vehicle. Not all title transactions represent changes in ownership. To provide estimated number of owners, CARFAX proprietary technology analyzes

all the events in a vehicle history. Estimated ownership is available for vehicles manufactured after 1991 and titled solely in the US including Puerto Rico. Dealers sometimes opt to take ownership of a vehicle and are required to in the following states: Maine, Massachusetts, New Jersey, Ohio, Oklahoma, Pennsylvania and South Dakota. Please consider this as you review a vehicle's estimated ownership history.

Repossession

When a repossession occurs a vehicle owner fails to make loan payments, and the financial institution holding the title takes possession of the vehicle.

Title Issued

A state issues a title to provide a vehicle owner with proof of ownership. Each title has a unique number. Each title or registration record on a CARFAX report does not necessarily indicate a change in ownership. In Canada, a registration and bill of sale are used as proof of ownership.

Follow Us:  [facebook.com/CARFAX](https://www.facebook.com/CARFAX)  [@CARFAXinc](https://twitter.com/CARFAXinc)  [About CARFAX](#)

CARFAX DEPENDS ON ITS SOURCES FOR THE ACCURACY AND RELIABILITY OF ITS INFORMATION. THEREFORE, NO RESPONSIBILITY IS ASSUMED BY CARFAX OR ITS AGENTS FOR ERRORS OR OMISSIONS IN THIS REPORT. CARFAX FURTHER EXPRESSLY DISCLAIMS ALL WARRANTIES, EXPRESS OR IMPLIED, INCLUDING ANY IMPLIED WARRANTIES OF MERCHANTABILITY OR FITNESS FOR A PARTICULAR PURPOSE.

© 2022 CARFAX, Inc., part of S&P Global. All rights reserved.
12/14/22 12:46:54 PM (CST)