



Vehicle History Report™

US \$44.99

2014 PORSCHE CAYENNE GTS

VIN: WP1AD2A21ELA78053
4 DOOR WAGON/SPORT UTILITY
4.8L V8 F DOHC 32V GASOLINE
ALL WHEEL DRIVE

Accident reported: moderate to severe damage

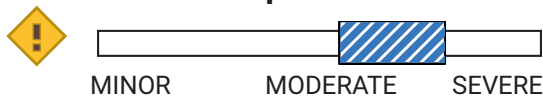

10 Service history records

3 Previous owners

Types of owners: Personal lease, Personal

71,553 Last reported odometer reading



This CARFAX Vehicle History Report is based only on information supplied to CARFAX and available as of 4/9/24 at 11:01:16 AM (CDT). Other information about this vehicle, including problems, may not have been reported to CARFAX. Use this report as one important tool, along with a vehicle inspection and test drive, to make a better decision about your next used car.

CARFAX Accident / Damage History

Not all accidents / issues are reported to CARFAX

Event 1

11/24/2014

Accident reported: moderate to severe damage with another motor vehicle

- Damage to undercarriage
- Vehicle drivable

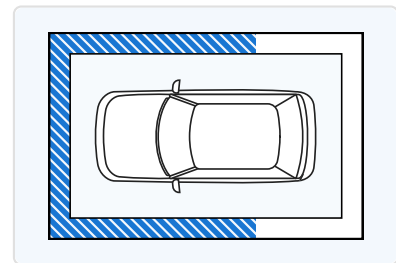
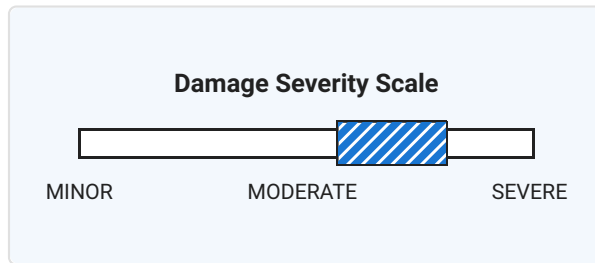

Event 2

03/23/2016

Vehicle inspected for prior damage

- Minor damage reported
- Cosmetic repairs found to: left side, right side, front-end

Event 3

07/12/2017

Damage reported: minor damage

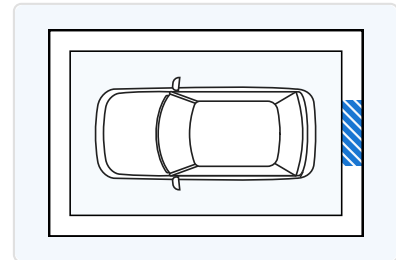
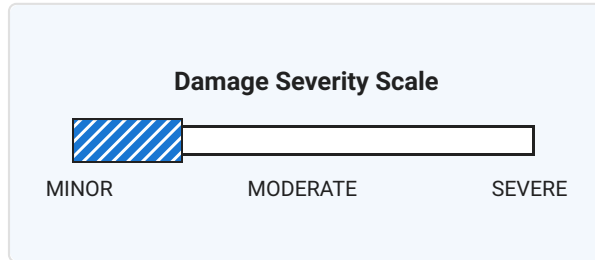

Additional History

Not all accidents / issues are reported to CARFAX

Total Loss

No total loss reported to CARFAX.

✓ No Issues Reported

Structural Damage

CARFAX recommends that you have this vehicle inspected by a collision repair specialist.

✓ No Issues Reported

Airbag Deployment No airbag deployment reported to CARFAX.	<input checked="" type="checkbox"/> No Issues Reported
Odometer Check No indication of an odometer rollback.	<input checked="" type="checkbox"/> No Issues Indicated
Accident / Damage Accident reported: 11/24/2014. Inspection found prior damage: 03/23/2016. Damage reported: 07/12/2017.	Accident Reported
Manufacturer Recall Check with an authorized Porsche dealer for any open recalls.	No Recalls Reported
Basic Warranty Original warranty estimated to have expired.	Warranty Expired



Title History

CARFAX guarantees the information in this section

Damage Brands Salvage Junk Rebuilt Fire Flood Hail Lemon	<input checked="" type="checkbox"/> Guaranteed No Problem
Odometer Brands Not Actual Mileage Exceeds Mechanical Limits	<input checked="" type="checkbox"/> Guaranteed No Problem

GUARANTEED - None of these title problems were reported by a U.S. state Department of Motor Vehicles (DMV). If you find that any of these title problems were reported by a DMV and not included in this report, you may qualify.

[View Terms](#) | [View Certificate](#)



Ownership History

The number of owners is estimated

Year purchased
Type of owner
Estimated length of ownership
Owned in the following states/provinces
Estimated miles driven per year
Last reported odometer reading



Detailed History



Owner 1
Purchased:
2014

Personal Lease
Vehicle
15,307 mi/yr

Date	Mileage	Source	Comments
05/30/2014		New Jersey Motor Vehicle Dept. West Long Branch, NJ	Registration issued or renewed - Vehicle color noted as White
05/31/2014		Dealer Inventory	Vehicle offered for sale
06/11/2014	20	New Jersey Motor Vehicle Dept. Lisle, IL Title #GD20141621198	Title issued or updated - First owner reported - Titled or registered as personal lease vehicle - Vehicle color noted as White



Two states? Vehicle leasing companies often title a car in one state but register it to be driven in another.

11/24/2014

Damage Report



Accident reported: moderate to severe damage with another motor vehicle

- Damage to front
- Damage to left front
- Damage to left side
- Damage to right front
- Damage to right side
- Damage to undercarriage
- Vehicle drivable

Damage Severity Scale

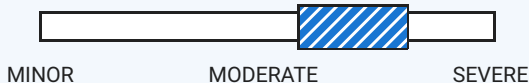

Damage Location

FRONT



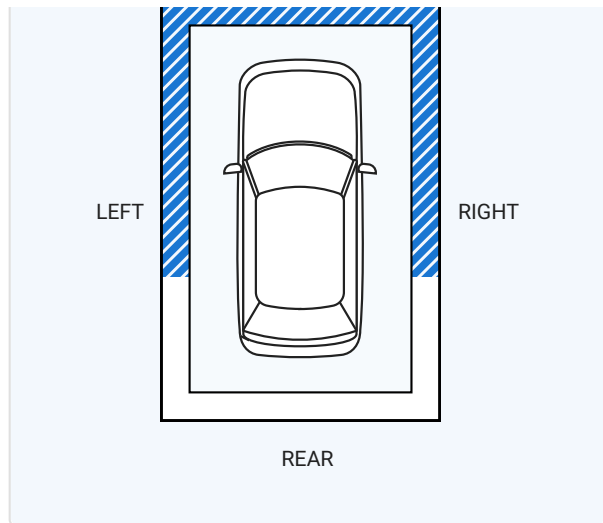

Safety first! In accidents like this, airbags may deploy and need replacing. Get them inspected before you buy. Airbag Tips

12/10/2015 21,823 Porsche Monmouth
West Long Branch, NJ
732-935-7600
porschemonmouth.com
★ 4.9 / 5.0
313 Verified Reviews ✓
❤️ 3,469 Customer Favorites



Vehicle serviced

- Maintenance inspection completed
- 20,000 mile service performed
- Interior trim checked
- Engine/powertrain computer/module checked

01/26/2016 24,496 Porsche Monmouth
West Long Branch, NJ
732-935-7600
porschemonmouth.com
★ 4.9 / 5.0
313 Verified Reviews ✓
❤️ 3,469 Customer Favorites



Vehicle serviced

- Maintenance inspection completed
- Drivability/performance checked
- Engine/powertrain computer/module checked

03/21/2016 27,722 Auto Auction

Listed as a dealer vehicle

- Vehicle sold



Millions of used vehicles are bought and sold at auction every year.

03/23/2016

TR1E360



Vehicle inspected for prior damage

03/23/2016

TRUE360
Inspection Report
true360.com



Vehicle inspected for prior damage
- Minor damage reported
- Cosmetic repairs found to: left side, right side, front-end

View the complete [TRUE360 Report](#)

03/31/2016

Dealer Inventory

Vehicle offered for sale

04/01/2016

Georgia
Motor Vehicle Dept.

Vehicle purchase reported

05/03/2016

New Jersey
Motor Vehicle Dept.
Edison, NJ
Title #DA20161240034

Dealer took registration of this vehicle
- Title issued or updated
- Dealer took title of this vehicle while it was in inventory
- Vehicle color noted as White



Owner 2
Purchased:
2016



Low mileage! This owner drove less than the industry average of 15,000 miles per year.

Personal
Vehicle
6,600 mi/yr

Date

Mileage Source

Comments

05/15/2016 27,832

Georgia
Motor Vehicle Dept.
Alpharetta, GA
Title
#770388161366963

Vehicle purchase reported
- Title issued or updated
- Registration issued or renewed
- Title or registration issued
- New owner reported
- Loan or lien reported
- Vehicle color noted as White

03/05/2017 32,940

Georgia
Inspection Station

Passed emissions inspection

03/24/2017

Georgia
Motor Vehicle Dept.
Alpharetta, GA
Title
#770388161366963

Registration issued or renewed
- Loan or lien reported
- Vehicle color noted as White

07/12/2017

Damage Report









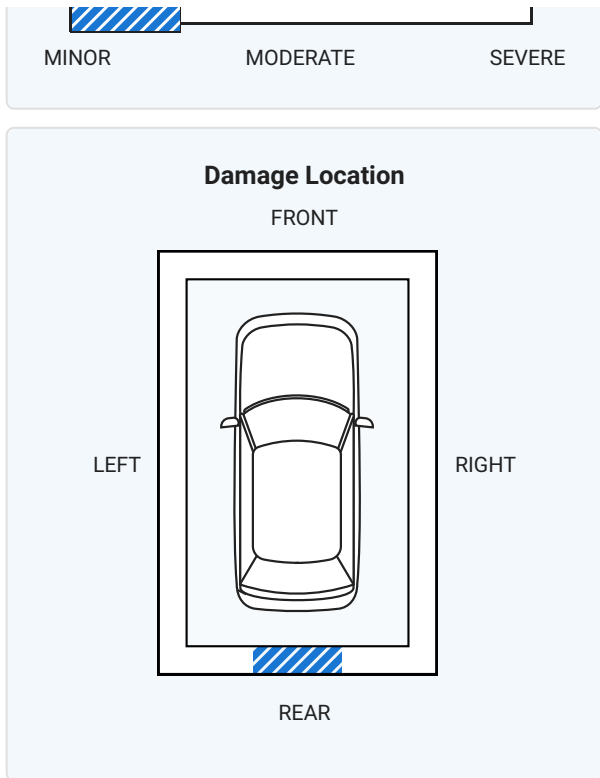



Damage reported: minor damage
- Damage to rear

Damage Severity Scale





03/15/2018 38,445	Georgia Inspection Station	Passed emissions inspection
03/15/2018	Georgia Motor Vehicle Dept. Alpharetta, GA Title #770388161366963	Registration issued or renewed - Loan or lien reported - Vehicle color noted as White
04/23/2019 44,204	Hennessy Porsche Roswell, GA 800-471-0911 hennessyporsche.com ★ 4.7 / 5.0 329 Verified Reviews ✓ ❤️ 5,346 Customer Favorites	 Vehicle serviced - Recommended maintenance performed - Maintenance inspection completed - Four wheel alignment performed - Wheels checked - Vehicle washed/detailed - Four tires replaced - Four tires balanced - Four tires mounted - Oil and filter changed
05/08/2019 44,666	Georgia Inspection Station	Passed emissions inspection
05/09/2019	Georgia Motor Vehicle Dept. Roswell, GA	Registration issued or renewed - Loan or lien reported - Registration updated when owner

	Roswell, GA Title #770388161366963	- Registration updated when owner moved the vehicle to a new location - Vehicle color noted as White
08/19/2019 49,235	<p>Hennessy Porsche Roswell, GA 800-471-0911 hennessyporsche.com</p> <p>★ 4.7 / 5.0 329 Verified Reviews   5,346 Customer Favorites</p>	<p> Vehicle serviced</p> <ul style="list-style-type: none"> - Maintenance inspection completed - One tire replaced - Vehicle washed/detailed - One tire mounted - One tire balanced
09/10/2019 50,399	<p>Hennessy Porsche Roswell, GA 800-471-0911 hennessyporsche.com</p> <p>★ 4.7 / 5.0 329 Verified Reviews   5,346 Customer Favorites</p>	<p> Vehicle serviced</p> <ul style="list-style-type: none"> - Maintenance inspection completed - One tire replaced - Vehicle washed/detailed - One tire mounted - One tire balanced
11/09/2019	<p>Georgia Motor Vehicle Dept. Roswell, GA Title #770388161366963</p>	<p>Registration issued or renewed</p> <ul style="list-style-type: none"> - Loan or lien reported - Vehicle color noted as White
04/16/2020 53,950	<p>Hennessy Porsche Roswell, GA 800-471-0911 hennessyporsche.com</p> <p>★ 4.7 / 5.0 329 Verified Reviews   5,346 Customer Favorites</p>	<p> Vehicle serviced</p> <ul style="list-style-type: none"> - Maintenance inspection completed - 60,000 mile service performed - One tire replaced - Four wheel alignment performed - Brake fluid flushed/changed - Vehicle washed/detailed - Alignment performed
05/06/2020 54,609	<p>Georgia Inspection Station</p>	<p>Passed emissions inspection</p>
05/07/2020	<p>Georgia Motor Vehicle Dept. Roswell, GA Title #770388161366963</p>	<p>Title or registration issued</p> <ul style="list-style-type: none"> - Loan or lien reported - Vehicle color noted as White
08/31/2020 56,203	<p>Georgia Inspection Station</p>	<p>Passed emissions inspection</p>





Owner 3
Purchased:
2020



Low mileage! This owner drove less than the industry average of 15,000 miles per year.

Personal
Vehicle
4,897 mi/yr

Date	Mileage	Source	Comments
10/27/2020	56,231	Florida Motor Vehicle Dept. Naples, FL Title #0140226104	Vehicle purchase reported - Title issued or updated - Registration issued or renewed - New owner reported - Titled or registered as personal vehicle - Loan or lien reported - Vehicle color noted as White
01/14/2021	57,085	Porsche of Naples Naples, FL 239-280-5100 porscheofnaples.com ★ 4.9 / 5.0 129 Verified Reviews ✓ ❤️ 32 Customer Favorites	 Vehicle serviced - Maintenance inspection completed
09/09/2021		Florida Motor Vehicle Dept. Naples, FL Title #0140226104	Registration issued or renewed - Titled or registered as personal vehicle - Loan or lien reported - Vehicle color noted as White
11/08/2021	61,148	Porsche of Naples Naples, FL 239-280-5100 porscheofnaples.com ★ 4.9 / 5.0 129 Verified Reviews ✓ ❤️ 32 Customer Favorites	 Vehicle serviced - Recommended maintenance performed - Maintenance inspection completed - Steering/suspension checked - Two tires mounted - Tire condition and pressure checked - Drivability/performance checked - Tire(s) replaced - Oil and filter changed - Fluids checked
06/02/2023	69,300	Porsche of Naples Naples, FL 239-280-5100	 Vehicle serviced - Recommended maintenance performed

239-280-5100
porscheofnaples.com

★ 4.9 / 5.0

129 Verified Reviews 

♥ 32 Customer Favorites

- performed
- Maintenance inspection completed
 - Brake fluid flushed/changed
 - Drivability/performance checked
 - Body electrical system checked
 - Serpentine belt replaced
 - Drive belt(s) replaced
 - Wheel(s) repaired
 - Oil and filter changed
 - Tire condition and pressure checked
 - Drive belt tensioner replaced
 - Brakes checked

09/06/2023

Florida
Motor Vehicle Dept.
Naples, FL
Title #0140226104

Registration issued or renewed

- Titled or registered as personal vehicle
- Loan or lien reported
- Vehicle color noted as White



Avoid financial headaches. Make sure the loan has been paid off if you're buying from a private seller. [Learn More](#)

12/13/2023 71,553

Porsche of Fort Myers
Fort Myers, FL
239-225-7601
porscheofftmyers.com

★ 4.8 / 5.0

92 Verified Reviews 

♥ 43 Customer Favorites



Vehicle serviced

- Maintenance inspection completed
- Engine oil/fluid leak checked
- Engine/powertrain computer/module checked
- Vehicle washed/detailed
- Valve cover gasket(s) replaced

Have Questions? Consumers, please visit our Help Center at www.carfax.com. Dealers or Subscribers, please visit our Help Center at www.carfaxonline.com.



Glossary

Accident Indicator

CARFAX receives information about accidents in all 50 states, the District of Columbia and Canada.

Not every accident is reported to CARFAX. As details about the accident become available, those additional details are added to the CARFAX Vehicle History Report. CARFAX recommends that you have this vehicle inspected by a qualified mechanic.

- According to the National Safety Council, Injury Facts, 2021 edition, 5% of the 276 million

registered vehicles in the U.S. were involved in an accident in 2019. Over 77% of these were considered minor or moderate.

- This CARFAX Vehicle History Report is based only on information supplied to CARFAX and available as of 4/9/24 at 11:01:16 AM (CDT). Other information about this vehicle, including problems, may not have been reported to CARFAX. Use this report as one important tool, along with a vehicle inspection and test drive, to make a better decision about your next used car.

Damage Indicator

Damage can be a result of many different types of events. Examples include contact with objects (other cars, trees, traffic signs, road debris, etc), vandalism, or weather-related events. Not every damage event is reported to CARFAX. As details about the damage event become available, those additional details are added to the CARFAX Vehicle History Report. CARFAX recommends that you have this vehicle inspected by a qualified mechanic.

- This CARFAX Vehicle History Report is based only on information supplied to CARFAX and available as of 4/9/24 at 11:01:16 AM (CDT). Other information about this vehicle, including problems, may not have been reported to CARFAX. Use this report as one important tool, along with a vehicle inspection and test drive, to make a better decision about your next used car.

Damage Severity

Damage events result in one of the following severity levels:

- Minor: Generally, minor damage is cosmetic (including dents or scratches), may only require reconditioning, and typically does not compromise a vehicle's operation and/or safety.
- Moderate: Moderate damage may affect multiple components of the vehicle and may impair the vehicle's operation and/or safety.
- Severe: Severe damage usually affects multiple components of the vehicle and is likely to compromise the vehicle's operation and/or safety.

CARFAX recommends getting a pre-purchase inspection at a certified collision repair facility.

First Owner

When the first owner(s) obtains a title from a Department of Motor Vehicles as proof of ownership.

New Owner Reported

When a vehicle is sold to a new owner, the Title must be transferred to the new owner(s) at a Department of Motor Vehicles.

Ownership History

CARFAX defines an owner as an individual or business that possesses and uses a vehicle. Not all title transactions represent changes in ownership. To provide estimated number of owners, CARFAX proprietary technology analyzes all the events in a vehicle history. Estimated ownership is available for vehicles manufactured after 1991 and titled solely in the US including Puerto Rico. Dealers sometimes opt to take ownership of a vehicle and are required to in the following states: Maine, Massachusetts, New Jersey, Ohio, Oklahoma, Pennsylvania and South Dakota. Please consider this as you review a vehicle's estimated ownership history.

Title Issued

A state issues a title to provide a vehicle owner with proof of ownership. Each title has a unique number. Each title or registration record on a CARFAX report does not necessarily indicate a change in ownership. In Canada, a registration and bill of sale are used as proof of ownership.

Follow Us:



facebook.com/CARFAX



@CARFAXinc



About CARFAX

CARFAX DEPENDS ON ITS SOURCES FOR THE ACCURACY AND RELIABILITY OF ITS INFORMATION. THEREFORE, NO RESPONSIBILITY IS ASSUMED BY CARFAX OR ITS AGENTS FOR ERRORS OR OMISSIONS IN THIS REPORT. CARFAX FURTHER EXPRESSLY DISCLAIMS ALL WARRANTIES, EXPRESS OR IMPLIED, INCLUDING ANY IMPLIED WARRANTIES OF MERCHANTABILITY OR FITNESS FOR A PARTICULAR PURPOSE.

© 2024 CARFAX, Inc., part of S&P Global. All rights reserved.
4/9/24 11:01:16 AM (CDT)

I have reviewed and received a copy of the CARFAX Vehicle History Report for this 2014 PORSCHE CAYENNE vehicle (VIN: WP1AD2A21ELA78053), which is based on information supplied to CARFAX and available as of 4/9/24 at 12:01 PM (EDT).

Customer Signature

Date

Dealer Signature

Date