



Report

US \$44.99

2017 Mercedes-Benz GLS 450

76,736 mi | VIN: 4JGDF6EE7HA976043 |

4 Door Wagon/Sport Utility | 3.0L V6 F DOHC 24V | Gasoline | All wheel drive



Regular oil changes

2 Previous owners

Types of owners: Corporate, Personal

Last owned in Florida

32 Detailed records available

This CARFAX Vehicle History Report is based only on information supplied to CARFAX and available as of 4/13/26 at 10:45:43 PM (CDT). Other information about this vehicle, including problems, may not have been reported to CARFAX. Use this report as one important tool, along with a vehicle inspection and test drive, to make a better decision about your next used car.



Accident / Damage History

Not all accidents / issues are reported to CARFAX

Event 1

04/16/2025

Damage reported: minor damage

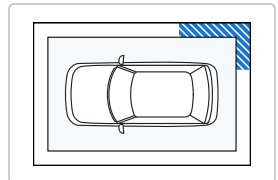
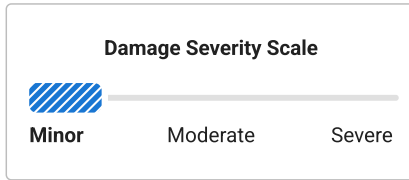

Recent Service Highlights

Key services performed in the last 12 months

Service	Comments	Date
Oil	✓ Oil and filter changed	09/25/2025
Tires	rotated	09/25/2025





This car has been recently serviced. That's a good thing!





CARFAX Additional History Not all accidents / issues are reported to CARFAX	Owner 1	Owner 2
Total Loss No total loss reported to CARFAX.	✔ No Issues Reported	✔ No Issues Reported
Structural Damage CARFAX recommends that you have this vehicle inspected by a collision repair specialist.	✔ No Issues Reported	✔ No Issues Reported
Airbag Deployment No airbag deployment reported to CARFAX.	✔ No Issues Reported	✔ No Issues Reported
Odometer Check No indication of an odometer rollback.	✔ No Issues Indicated	✔ No Issues Indicated
Accident / Damage Damage reported: 04/16/2025.	✔ No Issues Reported	Minor Damage
Manufacturer Recall No open recalls reported to CARFAX.	✔ No Recalls Reported	✔ No Recalls Reported
Basic Warranty Original warranty estimated to have expired.	Warranty Expired	Warranty Expired

CARFAX Title History CARFAX guarantees the information in this section	Owner 1	Owner 2
Damage Brands Salvage Junk Rebuilt Fire Flood Hail Lemon	✔ Guaranteed No Problem	✔ Guaranteed No Problem
Odometer Brands Not Actual Mileage Exceeds Mechanical Limits	✔ Guaranteed No Problem	✔ Guaranteed No Problem

 **GUARANTEED** - None of these title problems were reported by a U.S. state Department of Motor Vehicles (DMV). If you find that any of these title problems were reported by a DMV and not included in this report, you may qualify. [View Terms](#) | [View Certificate](#)

CARFAX Ownership History The number of owners is estimated	Owner 1	Owner 2
Year purchased	2017	2020
Type of owner	Corporate	Personal
Estimated length of ownership	3 years	5 yrs. 8 mo.
Owned in the following states/provinces	Florida	Florida
Estimated miles driven per year	10,491/yr	8,689/yr
Last reported odometer reading	31,537	76,736

CARFAX Detailed History			
 Owner 1 Purchased: 2017		Low mileage! This owner drove less than the industry average of 15,000 miles per year.	Corporate Vehicle 10,491 mi/yr
Date	Mileage	Source	Comments
05/24/2017	1	Mercedes-Benz of Cutler Bay Cutler Bay, FL 305-251-0345 mbcutlerbay.com ★ 4.7 / 5.0 752 Verified Reviews	Vehicle offered for sale

05/25/2017	5	Mercedes-Benz Cutler Bay Cutler Bay, FL 786-232-0702 mbcutlerbay.com/ ★ 4.7 / 5.0 531 Verified Reviews ♥ 22 Customer Favorites		Vehicle serviced - Pre-delivery inspection completed
06/30/2017		Mercedes-Benz of Cutler Bay Cutler Bay, FL 305-251-0345 mbcutlerbay.com ★ 4.7 / 5.0 752 Verified Reviews		Vehicle sold
06/30/2017		Florida Motor Vehicle Dept.		Vehicle purchase reported - Titled or registered as corporate vehicle
07/28/2017	9	Mercedes-Benz Cutler Bay Cutler Bay, FL 786-232-0702 mbcutlerbay.com/ ★ 4.7 / 5.0 531 Verified Reviews ♥ 22 Customer Favorites		Vehicle serviced - Pre-delivery inspection completed
08/01/2017	50	Florida Motor Vehicle Dept. Miami, FL Title #0128069781		Title issued or updated - Registration issued or renewed - First owner reported - Loan or lien reported - Vehicle color noted as Blue
08/08/2017		Florida Motor Vehicle Dept. Roanoke, TX Title #0128069781		Title issued or updated - Loan or lien reported - Vehicle color noted as Blue
07/27/2018		Florida Motor Vehicle Dept. Miami, FL Title #0128069781		Registration issued or renewed - Loan or lien reported - Vehicle color noted as Blue
08/15/2018	10,601	Mercedes-Benz Cutler Bay Cutler Bay, FL 786-232-0702 mbcutlerbay.com/ ★ 4.7 / 5.0 531 Verified Reviews ♥ 22 Customer Favorites		Vehicle serviced - Maintenance inspection completed - Vehicle washed/detailed
07/12/2019		Florida Motor Vehicle Dept. Miami, FL Title #0128069781		Registration issued or renewed - Loan or lien reported - Vehicle color noted as Blue
08/10/2019	20,995	Mercedes-Benz of Coconut Creek Coral Springs, FL 954-406-1167 mercedesfla.com ★ 4.5 / 5.0 371 Verified Reviews ♥ 182 Customer Favorites		Vehicle serviced - Maintenance inspection completed - 20,000 mile service performed - Antifreeze/coolant checked - Axles checked - Battery/charging system checked - Brakes checked - Brake fluid checked - Brake fluid flushed/changed - Cabin air filter replaced/cleaned - Drive belts checked - Driveshaft checked - Electrical system checked - Engine checked - Evaporator case drain hose serviced - Fluids checked - Front brake pads replaced - Front brake rotor(s) replaced - Hood operation checked - Interior cleaned - Maintenance reminder reset

- Oil and filter changed
- Parking brake system checked
- Power steering checked
- Safety inspection performed
- Steering/suspension checked
- Tire condition and pressure checked



07/01/2020	31,532	Mercedes-Benz Financial Services Florida	Lease vehicle returned to dealer
07/04/2020	31,537	Mercedes-Benz of Cutler Bay Cutler Bay, FL ★ 4.7 / 5.0 752 Verified Reviews	Vehicle offered for sale
07/06/2020		Mercedes-Benz Dealer Miami, FL	Vehicle offered for sale
07/10/2020		Mercedes-Benz Cutler Bay Cutler Bay, FL 786-232-0702 mbcutlerbay.com/ ★ 4.7 / 5.0 531 Verified Reviews ♥ 22 Customer Favorites	 Vehicle serviced - Pre-delivery inspection completed - Recommended maintenance performed - Brakes checked - Brake fluid flushed/changed - Four tires replaced - Four wheel alignment performed - Tire condition and pressure checked - Wheel(s) repaired - Vehicle washed/detailed
07/13/2020		Mercedes-Benz Cutler Bay Cutler Bay, FL 786-232-0702 mbcutlerbay.com/ ★ 4.7 / 5.0 531 Verified Reviews ♥ 22 Customer Favorites	Vehicle sold



 **Owner 2**
Purchased: 2020



Low mileage! This owner drove less than the industry average of 15,000 miles per year.

Personal Vehicle
8,689 mi/yr

Date	Mileage	Source	Comments
07/13/2020		Florida Motor Vehicle Dept. Tavernier, FL Title #0128069781	Vehicle purchase reported - Title issued or updated - Registration issued or renewed - New owner reported - Titled or registered as personal vehicle - Loan or lien reported - Vehicle color noted as Blue
07/25/2020	31,791	Mercedes-Benz Cutler Bay Cutler Bay, FL 786-232-0702 mbcutlerbay.com/ ★ 4.7 / 5.0 531 Verified Reviews ♥ 22 Customer Favorites	 Vehicle serviced - Maintenance inspection completed - Noise checked - Rear shock absorber(s) replaced - Vehicle washed/detailed
08/05/2020		Florida Motor Vehicle Dept. Tavernier, FL Title #0128069781	Title issued or updated - Registration issued or renewed - Titled or registered as personal vehicle - Loan or lien reported - Vehicle color noted as Blue
06/23/2021	42,116	Mercedes-Benz Cutler Bay Cutler Bay, FL 786-232-0702 mbcutlerbay.com/ ★ 4.7 / 5.0 531 Verified Reviews ♥ 22 Customer Favorites	 Vehicle serviced - Maintenance inspection completed - Brake fluid flushed/changed - Front wiper blades/refills replaced - Fuel system cleaned/serviced - Oil and filter changed - Tires rotated - Vehicle washed/detailed

09/13/2021		Florida Motor Vehicle Dept. Tavernier, FL Title #0128069781		Registration issued or renewed - Titled or registered as personal vehicle - Loan or lien reported - Vehicle color noted as Blue
08/30/2022		Florida Motor Vehicle Dept. Tavernier, FL Title #0128069781		Registration issued or renewed - Titled or registered as personal vehicle - Loan or lien reported - Vehicle color noted as Blue
10/28/2022	52,453	Mercedes-Benz Cutler Bay Cutler Bay, FL 786-232-0702 mbcutlerbay.com/ ★ 4.7 / 5.0 531 Verified Reviews ♥ 22 Customer Favorites		Vehicle serviced - Maintenance inspection completed - Drivability/performance checked - Electrical system checked - Engine mount(s) replaced - Fuel system cleaned/serviced - Oil and filter changed - Spark plug(s) replaced - Vehicle washed/detailed
08/22/2023		Florida Motor Vehicle Dept. Tavernier, FL Title #0128069781		Registration issued or renewed - Titled or registered as personal vehicle - Loan or lien reported - Vehicle color noted as Blue
11/30/2023		Florida Motor Vehicle Dept. Tavernier, FL Title #0128069781		Registration issued or renewed - Titled or registered as personal vehicle - Loan or lien reported - Vehicle color noted as Blue
05/22/2024	66,621	Mercedes-Benz Cutler Bay Cutler Bay, FL 786-232-0702 mbcutlerbay.com/ ★ 4.7 / 5.0 531 Verified Reviews ♥ 22 Customer Favorites		Vehicle serviced - Maintenance inspection completed - Air suspension checked - Antifreeze/coolant flushed/changed - Electrical system checked - Engine cleaned - Engine/powertrain computer/module checked - Engine/powertrain computer/module reprogrammed - Fuel system cleaned/serviced - Oil and filter changed - Wheel(s) replaced - Wiper(s) replaced - Vehicle washed/detailed
09/05/2024		Florida Motor Vehicle Dept. Tavernier, FL Title #0128069781		Registration issued or renewed - Titled or registered as personal vehicle - Loan or lien reported - Vehicle color noted as Blue
04/02/2025		Sport Subaru Orlando, FL 407-291-1448 sportsubaru.com/ ★ 4.8 / 5.0 1,751 Verified Reviews ♥ 13,703 Customer Favorites		Inspection performed - Tire checked View the complete inspection report
04/16/2025		Damage Report		Damage reported: minor damage - Damage to right rear

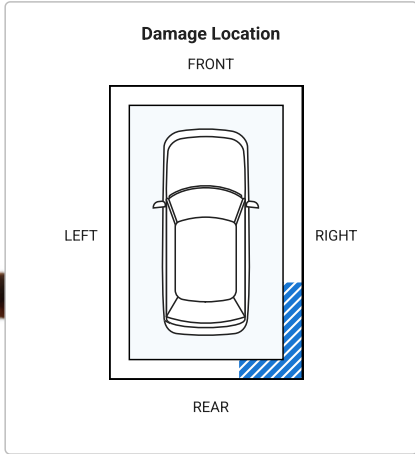
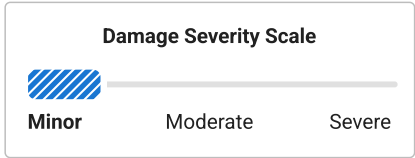

CARFAX HAS THE MOST ACCIDENT & DAMAGE INFORMATION



Minor damage is usually cosmetic, including dents or scratches to the vehicle body.

08/19/2025

Florida
Motor Vehicle Dept.
Tavernier, FL
Title #0128069781

Registration issued or renewed
- Titled or registered as personal vehicle
- Loan or lien reported
- Vehicle color noted as Blue



Avoid financial headaches. Make sure the loan has been paid off if you're buying from a private seller. [Learn More](#)

09/25/2025

76,736

Mercedes-Benz Cutler Bay
Cutler Bay, FL
786-232-0702
mbcutlerbay.com/
★ 4.7 / 5.0 531 Verified Reviews



Vehicle serviced
- Maintenance inspection completed
- Oil and filter changed
- Tires rotated
- Transmission fluid changed
- Vehicle washed/detailed

♥ 22 Customer Favorites

04/10/2026

Online Listing

Vehicle offered for sale



This vehicle's oil change history, as reported to CARFAX, follows the manufacturer's recommendation. Track your service history for free at carfax.com/service.

Have Questions? Consumers, please visit our Help Center at www.carfax.com. Dealers or Subscribers, please visit our Help Center at www.carfaxonline.com.

CARFAX Glossary

CARFAX Well Maintained - Regular Oil Changes

CARFAX identifies a "Well Maintained - Regular Oil Change" vehicle as having a regular oil change history when all its recommended oil changes, based on the vehicle's maintenance schedule, have been reported to CARFAX. CARFAX uses the manufacturer's schedule and assumes normal driving conditions. When an oil change schedule is not available, CARFAX may analyze reported service events to determine what is typical for the same make and model vehicle. Dealers and service shops may publish different recommended service schedules.

Damage Indicator

Damage can be a result of many different types of events. Examples include contact with objects (other cars, trees, traffic signs, road debris, etc), vandalism, or weather-related events. Not every damage event is reported to CARFAX. As details about the damage event become available, those additional details are added to the CARFAX Vehicle History Report. CARFAX recommends that you have this vehicle inspected by a qualified mechanic.

- This CARFAX Vehicle History Report is based only on information supplied to CARFAX and available as of 4/13/26 at 10:45:43 PM (CDT). Other information about this vehicle, including problems, may not have been reported to CARFAX. Use this report as one important tool, along with a vehicle inspection and test drive, to make a better decision about your next used car.

Damage Severity

Damage events result in one of the following severity levels:

- Minor: Generally, minor damage is cosmetic (including dents or scratches), may only require reconditioning, and typically does not compromise a vehicle's operation and/or safety.
- Moderate: Moderate damage may affect multiple components of the vehicle and may impair the vehicle's operation and/or safety.
- Severe: Severe damage usually affects multiple components of the vehicle and is likely to compromise the vehicle's operation and/or safety.

CARFAX recommends getting a pre-purchase inspection at a certified collision repair facility.

First Owner

When the first owner(s) obtains a title from a Department of Motor Vehicles as proof of ownership.

New Owner Reported



When a vehicle is sold to a new owner, the Title must be transferred to the new owner(s) at a Department of Motor Vehicles.

Ownership History

CARFAX defines an owner as an individual or business that possesses and uses a vehicle. Not all title transactions represent changes in ownership. To provide estimated number of owners, CARFAX proprietary technology analyzes all the events in a vehicle history. Estimated ownership is available for vehicles manufactured after 1991 and titled solely in the US including Puerto Rico. Dealers sometimes opt to take ownership of a vehicle and are required to in the following states: Maine, Massachusetts, New Jersey, Ohio, Oklahoma, Pennsylvania and South Dakota. Please consider this as you review a vehicle's estimated ownership history.

Title Issued

A state issues a title to provide a vehicle owner with proof of ownership. Each title has a unique number. Each title or registration record on a CARFAX report does not necessarily indicate a change in ownership. In Canada, a registration and bill of sale are used as proof of ownership.

Follow Us:  facebook.com/CARFAX  [@CARFAXinc](https://twitter.com/CARFAXinc)  [About CARFAX](#)

CARFAX DEPENDS ON ITS SOURCES FOR THE ACCURACY AND RELIABILITY OF ITS INFORMATION. THEREFORE, NO RESPONSIBILITY IS ASSUMED BY CARFAX OR ITS AGENTS FOR ERRORS OR OMISSIONS IN THIS REPORT. CARFAX FURTHER EXPRESSLY DISCLAIMS ALL WARRANTIES, EXPRESS OR IMPLIED, INCLUDING ANY IMPLIED WARRANTIES OF MERCHANTABILITY OR FITNESS FOR A PARTICULAR PURPOSE.

© 2026 CARFAX, Inc., part of S&P Global. All rights reserved.
4/13/26 10:45:43 PM (CDT)

I have reviewed and received a copy of the CARFAX Vehicle History Report for this 2017 MERCEDES-BENZ GLS vehicle (VIN: 4JGDF6EE7HA976043), which is based on information supplied to CARFAX and available as of 4/13/26 at 11:45 PM (EDT).

Customer Signature

Date

Dealer Signature

Date



Report

US \$44.99

2017 Mercedes-Benz GLS 450

76,736 mi | VIN: 4JGDF6EE7HA976043 |

4 Door Wagon/Sport Utility | 3.0L V6 F DOHC 24V | Gasoline | All wheel drive

DAMAGE Minor Damage



Minor

Moderate

Severe

CARFAX VALUE \$20,640

Regular oil changes

2 Previous owners

Types of owners: Corporate, Personal

Last owned in Florida

32 Detailed records available

This CARFAX Vehicle History Report is based only on information supplied to CARFAX and available as of 4/13/26 at 10:45:43 PM (CDT). Other information about this vehicle, including problems, may not have been reported to CARFAX. Use this report as one important tool, along with a vehicle inspection and test drive, to make a better decision about your next used car.



Accident / Damage History

Not all accidents / issues are reported to CARFAX

Event 1

04/16/2025

Damage reported: minor damage

Damage Severity Scale



Minor

Moderate

Severe

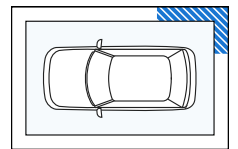

Recent Service Highlights

Key services performed in the last 12 months

Service	Comments	Date
Oil	✓ Oil and filter changed	09/25/2025
Tires	✓ Tires rotated	09/25/2025

This car has been recently serviced. That's a good thing!









History-Based Value Report



\$20,640

CARFAX Retail Value



History events affecting this vehicle's value



-   Regular Oil Changes
-   Minor Damage

 Additional History Not all accidents / issues are reported to CARFAX	 Owner 1	 Owner 2
Total Loss No total loss reported to CARFAX.	<input checked="" type="checkbox"/> No Issues Reported	<input checked="" type="checkbox"/> No Issues Reported
Structural Damage CARFAX recommends that you have this vehicle inspected by a collision repair specialist.	<input checked="" type="checkbox"/> No Issues Reported	<input checked="" type="checkbox"/> No Issues Reported
Airbag Deployment No airbag deployment reported to CARFAX.	<input checked="" type="checkbox"/> No Issues Reported	<input checked="" type="checkbox"/> No Issues Reported
Odometer Check No indication of an odometer rollback.	<input checked="" type="checkbox"/> No Issues Indicated	<input checked="" type="checkbox"/> No Issues Indicated
Accident / Damage Damage reported: 04/16/2025.	<input checked="" type="checkbox"/> No Issues Reported	Minor Damage
Manufacturer Recall No open recalls reported to CARFAX.	<input checked="" type="checkbox"/> No Recalls Reported	<input checked="" type="checkbox"/> No Recalls Reported
Basic Warranty Original warranty estimated to have expired.	Warranty Expired	Warranty Expired

 Title History CARFAX guarantees the information in this section	 Owner 1	 Owner 2
Damage Brands Salvage Junk Rebuilt Fire Flood Hail Lemon	<input checked="" type="checkbox"/> Guaranteed No Problem	<input checked="" type="checkbox"/> Guaranteed No Problem
Odometer Brands Not Actual Mileage Exceeds Mechanical Limits	<input checked="" type="checkbox"/> Guaranteed No Problem	<input checked="" type="checkbox"/> Guaranteed No Problem

 **GUARANTEED** - None of these title problems were reported by a U.S. state Department of Motor Vehicles (DMV). If you find that any of these title problems were reported by a DMV and not included in this report, you may qualify.
[View Terms](#) | [View Certificate](#)

 Ownership History The number of owners is estimated	 Owner 1	 Owner 2
Year purchased	2017	2020
Type of owner	Corporate	Personal
Estimated length of ownership	3 years	5 yrs. 8 mo.
Owned in the following states/provinces	Florida	Florida
Estimated miles driven per year	10,491/yr	8,689/yr
Last reported odometer reading	31,537	76,736

 Detailed History		
 Owner 1 Purchased: 2017		Corporate Vehicle 10,491 mi/yr

Low mileage! This owner drove less

Date	Mileage	Source	Comments
05/24/2017	1	Mercedes-Benz of Cutler Bay Cutler Bay, FL 305-251-0345 mbcutlerbay.com ★ 4.7 / 5.0 752 Verified Reviews	Vehicle offered for sale
05/25/2017	5	Mercedes-Benz Cutler Bay Cutler Bay, FL 786-232-0702 mbcutlerbay.com/ ★ 4.7 / 5.0 531 Verified Reviews ❤️ 22 Customer Favorites	 Vehicle serviced - Pre-delivery inspection completed
06/30/2017		Mercedes-Benz of Cutler Bay Cutler Bay, FL 305-251-0345 mbcutlerbay.com ★ 4.7 / 5.0 752 Verified Reviews	Vehicle sold
06/30/2017		Florida Motor Vehicle Dept.	Vehicle purchase reported - Titled or registered as corporate vehicle
07/28/2017	9	Mercedes-Benz Cutler Bay Cutler Bay, FL 786-232-0702 mbcutlerbay.com/ ★ 4.7 / 5.0 531 Verified Reviews ❤️ 22 Customer Favorites	 Vehicle serviced - Pre-delivery inspection completed
08/01/2017	50	Florida Motor Vehicle Dept. Miami, FL Title #0128069781	Title issued or updated - Registration issued or renewed - First owner reported - Loan or lien reported - Vehicle color noted as Blue
08/08/2017		Florida Motor Vehicle Dept. Roanoke, TX Title #0128069781	Title issued or updated - Loan or lien reported - Vehicle color noted as Blue
07/27/2018		Florida Motor Vehicle Dept. Miami, FL Title #0128069781	Registration issued or renewed - Loan or lien reported - Vehicle color noted as Blue
08/15/2018	10,601	Mercedes-Benz Cutler Bay Cutler Bay, FL 786-232-0702 mbcutlerbay.com/ ★ 4.7 / 5.0 531 Verified Reviews ❤️ 22 Customer Favorites	 Vehicle serviced - Maintenance inspection completed - Vehicle washed/detailed
07/12/2019		Florida Motor Vehicle Dept. Miami, FL Title #0128069781	Registration issued or renewed - Loan or lien reported - Vehicle color noted as Blue
08/10/2019	20,995	Mercedes-Benz of Coconut Creek Coral Springs, FL 954-406-1167 mercedesfla.com ★ 4.5 / 5.0 371 Verified Reviews ❤️ 182 Customer Favorites	 Vehicle serviced - Maintenance inspection completed - 20,000 mile service performed - Antifreeze/coolant checked - Axles checked - Battery/charging system checked - Brakes checked - Brake fluid checked - Brake fluid flushed/changed - Cabin air filter replaced/cleaned - Drive belts checked

- Driveshaft checked
- Electrical system checked
- Engine checked
- Evaporator case drain hose serviced
- Fluids checked
- Front brake pads replaced
- Front brake rotor(s) replaced
- Hood operation checked
- Interior cleaned
- Maintenance reminder reset
- Oil and filter changed
- Parking brake system checked
- Power steering checked
- Safety inspection performed
- Steering/suspension checked
- Tire condition and pressure checked





07/01/2020	31,532	Mercedes-Benz Financial Services Florida		Lease vehicle returned to dealer
07/04/2020	31,537	Mercedes-Benz of Cutler Bay Cutler Bay, FL ★ 4.7 / 5.0 752 Verified Reviews		Vehicle offered for sale
07/06/2020		Mercedes-Benz Dealer Miami, FL		Vehicle offered for sale
07/10/2020		Mercedes-Benz Cutler Bay Cutler Bay, FL 786-232-0702 mbcutlerbay.com/ ★ 4.7 / 5.0 531 Verified Reviews ♥ 22 Customer Favorites		Vehicle serviced - Pre-delivery inspection completed - Recommended maintenance performed - Brakes checked - Brake fluid flushed/changed - Four tires replaced - Four wheel alignment performed - Tire condition and pressure checked - Wheel(s) repaired - Vehicle washed/detailed
07/13/2020		Mercedes-Benz Cutler Bay Cutler Bay, FL 786-232-0702 mbcutlerbay.com/ ★ 4.7 / 5.0 531 Verified Reviews ♥ 22 Customer Favorites		Vehicle sold

 **Owner 2**
Purchased: 2020

Low mileage! This owner drove less than the industry average of 15,000 miles per year.

Personal Vehicle
8,689 mi/yr

Date	Mileage	Source		Comments
07/13/2020		Florida Motor Vehicle Dept. Tavernier, FL Title #0128069781		Vehicle purchase reported - Title issued or updated - Registration issued or renewed - New owner reported - Titled or registered as personal vehicle - Loan or lien reported - Vehicle color noted as Blue
07/25/2020	31,791	Mercedes-Benz Cutler Bay Cutler Bay, FL 786-232-0702 mbcutlerbay.com/ ★ 4.7 / 5.0 531 Verified Reviews ♥ 22 Customer Favorites		Vehicle serviced - Maintenance inspection completed - Noise checked - Rear shock absorber(s) replaced - Vehicle washed/detailed
08/05/2020		Florida Motor Vehicle Dept. Tavernier, FL Title #0128069781		Title issued or updated - Registration issued or renewed - Titled or registered as personal vehicle - Loan or lien reported - Vehicle color noted as Blue

06/23/2021	42,116	Mercedes-Benz Cutler Bay Cutler Bay, FL 786-232-0702 mbcutlerbay.com/ ★ 4.7 / 5.0 531 Verified Reviews ❤️ 22 Customer Favorites		Vehicle serviced - Maintenance inspection completed - Brake fluid flushed/changed - Front wiper blades/refills replaced - Fuel system cleaned/serviced - Oil and filter changed - Tires rotated - Vehicle washed/detailed
09/13/2021		Florida Motor Vehicle Dept. Tavernier, FL Title #0128069781		Registration issued or renewed - Titled or registered as personal vehicle - Loan or lien reported - Vehicle color noted as Blue
08/30/2022		Florida Motor Vehicle Dept. Tavernier, FL Title #0128069781		Registration issued or renewed - Titled or registered as personal vehicle - Loan or lien reported - Vehicle color noted as Blue
10/28/2022	52,453	Mercedes-Benz Cutler Bay Cutler Bay, FL 786-232-0702 mbcutlerbay.com/ ★ 4.7 / 5.0 531 Verified Reviews ❤️ 22 Customer Favorites		Vehicle serviced - Maintenance inspection completed - Drivability/performance checked - Electrical system checked - Engine mount(s) replaced - Fuel system cleaned/serviced - Oil and filter changed - Spark plug(s) replaced - Vehicle washed/detailed
08/22/2023		Florida Motor Vehicle Dept. Tavernier, FL Title #0128069781		Registration issued or renewed - Titled or registered as personal vehicle - Loan or lien reported - Vehicle color noted as Blue
11/30/2023		Florida Motor Vehicle Dept. Tavernier, FL Title #0128069781		Registration issued or renewed - Titled or registered as personal vehicle - Loan or lien reported - Vehicle color noted as Blue
05/22/2024	66,621	Mercedes-Benz Cutler Bay Cutler Bay, FL 786-232-0702 mbcutlerbay.com/ ★ 4.7 / 5.0 531 Verified Reviews ❤️ 22 Customer Favorites		Vehicle serviced - Maintenance inspection completed - Air suspension checked - Antifreeze/coolant flushed/changed - Electrical system checked - Engine cleaned - Engine/powertrain computer/module checked - Engine/powertrain computer/module reprogrammed - Fuel system cleaned/serviced - Oil and filter changed - Wheel(s) replaced - Wiper(s) replaced - Vehicle washed/detailed
09/05/2024		Florida Motor Vehicle Dept. Tavernier, FL Title #0128069781		Registration issued or renewed - Titled or registered as personal vehicle - Loan or lien reported - Vehicle color noted as Blue
04/02/2025		Sport Subaru Orlando, FL 407-291-1448 sportsubaru.com/ ★ 4.8 / 5.0 1,751 Verified Reviews ❤️ 13,703 Customer Favorites		Inspection performed - Tire checked View the complete inspection report
04/16/2025		Damage Report		Damage reported: minor damage - Damage to right rear

CARFAX HAS THE MOST ACCIDENT & DAMAGE INFORMATION

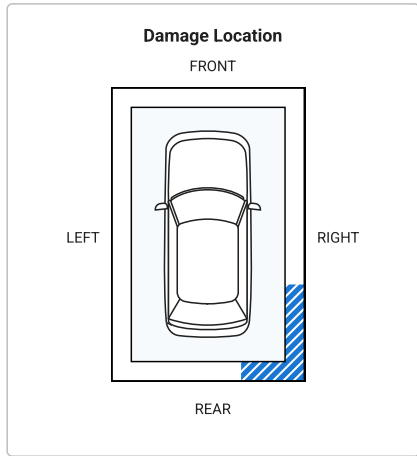
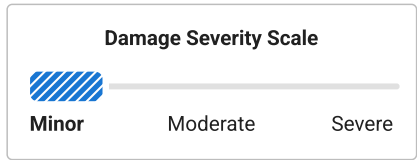

Minor damage is usually cosmetic, including dents or scratches to the vehicle body.

08/19/2025		Florida Motor Vehicle Dept. Tavernier, FL Title #0128069781		<p>Registration issued or renewed</p> <ul style="list-style-type: none"> - Titled or registered as personal vehicle - Loan or lien reported - Vehicle color noted as Blue
<p>Avoid financial headaches. Make sure the loan has been paid off if you're buying from a private seller. Learn More</p>				
09/25/2025	76,736	Mercedes-Benz Cutler Bay Cutler Bay, FL 786-232-0702 mbcutlerbay.com/ ★ 4.7 / 5.0 531 Verified Reviews ♥ 22 Customer Favorites		<p>Vehicle serviced</p> <ul style="list-style-type: none"> - Maintenance inspection completed - Oil and filter changed - Tires rotated - Transmission fluid changed - Vehicle washed/detailed
04/10/2026		Online Listing		<p>Vehicle offered for sale</p>
<p>This vehicle's oil change history, as reported to CARFAX, follows the manufacturer's recommendation. Track your service history for free at carfax.com/service.</p>				

Have Questions? Consumers, please visit our Help Center at www.carfax.com. Dealers or Subscribers, please visit our Help Center at www.carfaxonline.com.

CARFAX Glossary

CARFAX Well Maintained - Regular Oil Changes
 CARFAX identifies a "Well Maintained - Regular Oil Change" vehicle as having a regular oil change history when all its recommended oil changes, based on the vehicle's maintenance schedule, have been reported to CARFAX. CARFAX uses the manufacturer's schedule and assumes normal driving conditions. When an oil change schedule is not available, CARFAX may analyze reported service events to determine what is typical for the same make and model vehicle. Dealers and service shops may publish different recommended service schedules.

Damage Indicator
 Damage can be a result of many different types of events. Examples include contact with objects (other cars, trees, traffic signs, road debris, etc), vandalism, or weather-related events. Not every damage event is reported to CARFAX. As details about the damage event become available, those additional details are added to the CARFAX Vehicle History Report. CARFAX recommends that you have this vehicle inspected by a qualified mechanic.

- This CARFAX Vehicle History Report is based only on information supplied to CARFAX and available as of 4/13/26 at 10:45:43 PM (CDT). Other information about this vehicle, including problems, may not have been reported to CARFAX. Use this report as one important tool, along with a vehicle inspection and test drive, to make a better decision about your next used car.

Damage Severity
 Damage events result in one of the following severity levels:

- Minor: Generally, minor damage is cosmetic (including dents or scratches), may only require reconditioning, and typically does not compromise a vehicle's operation and/or safety.

- Moderate: Moderate damage may affect multiple components of the vehicle and may impair the vehicle's operation and/or safety.
- Severe: Severe damage usually affects multiple components of the vehicle and is likely to compromise the vehicle's operation and/or safety. CARFAX recommends getting a pre-purchase inspection at a certified collision repair facility.

First Owner

When the first owner(s) obtains a title from a Department of Motor Vehicles as proof of ownership.

New Owner Reported



When a vehicle is sold to a new owner, the Title must be transferred to the new owner(s) at a Department of Motor Vehicles.

Ownership History

CARFAX defines an owner as an individual or business that possesses and uses a vehicle. Not all title transactions represent changes in ownership. To provide estimated number of owners, CARFAX proprietary technology analyzes all the events in a vehicle history. Estimated ownership is available for vehicles manufactured after 1991 and titled solely in the US including Puerto Rico. Dealers sometimes opt to take ownership of a vehicle and are required to in the following states: Maine, Massachusetts, New Jersey, Ohio, Oklahoma, Pennsylvania and South Dakota. Please consider this as you review a vehicle's estimated ownership history.

Title Issued

A state issues a title to provide a vehicle owner with proof of ownership. Each title has a unique number. Each title or registration record on a CARFAX report does not necessarily indicate a change in ownership. In Canada, a registration and bill of sale are used as proof of ownership.

Follow Us:  facebook.com/CARFAX  [@CARFAXinc](https://twitter.com/CARFAXinc)  [About CARFAX](#)

CARFAX DEPENDS ON ITS SOURCES FOR THE ACCURACY AND RELIABILITY OF ITS INFORMATION. THEREFORE, NO RESPONSIBILITY IS ASSUMED BY CARFAX OR ITS AGENTS FOR ERRORS OR OMISSIONS IN THIS REPORT. CARFAX FURTHER EXPRESSLY DISCLAIMS ALL WARRANTIES, EXPRESS OR IMPLIED, INCLUDING ANY IMPLIED WARRANTIES OF MERCHANTABILITY OR FITNESS FOR A PARTICULAR PURPOSE.

© 2026 CARFAX, Inc., part of S&P Global. All rights reserved.
4/13/26 10:45:43 PM (CDT)

I have reviewed and received a copy of the CARFAX Vehicle History Report for this 2017 MERCEDES-BENZ GLS vehicle (VIN: 4JGDF6EE7HA976043), which is based on information supplied to CARFAX and available as of 4/13/26 at 11:45 PM (EDT).

Customer Signature

Date

Dealer Signature

Date